



SwitchBlade Windshield Mount Kit Q344-001 Chrome and Kit-Q344-002 Gloss Black

**Use with SwitchBlade Windshields:
2-UP®, Chopped®, Shorty™ or Deflector™
Spartan® Windshields
and
Wave QR® Windshields**

Thank you for purchasing a National Cycle product.

Dealers: If installing the mount kit for a customer please give them this manual. It contains information needed to properly maintain and use this product.

This product is covered by one or more of the following patents: 5732965, 6254166B1, 6974175B2. *All Patents Pending*

Attention



Special notes and cautionary measures which can prevent damage to the accessory or motorcycle.

Note:



Tips for facilitation of operation, control and adjustment, as well as maintenance work.

Parts List

INDEX	PART NUMBER	DESCRIPTION	QTY.
1	37-370864-000	Clamp, Outer, Left	1
2	37-370865-000	Clamp, Outer, Right	1
3	37-370866-000	Clamp, Inner	2
PARTS ASSEMBLED TO LEFT AND RIGHT BRACKET STUDS			
4	34-340501-000	Nut, Upper	2
5	34-340510-000	Spool w/Bushing, Upper	2
6	49-490414-000	Washer, Brass	2
7	34-340502-000	Nut, Lower	2
8	34-340512-000	Spool, Lower	2
BAG#1193			
9	75-766027-000	Clamp Spacer	4
10	51-516316-000	Screws, CS MS x 16	6
11	51-514217-000	Screws, CS Flat M6 x 16	2

PLEASE REFER TO PAGE 6 TO ORDER REPLACEMENT PARTS.

Preparation



Proper Tightening Of This Assembly Is Critical. Use A Torque Wrench!

Follow this procedure! Correct assembly of this kit will provide years of reliable service.

Position the motorcycle securely on a work stand.

Cover the front fender with a suitable cloth to avoid scratches from dropped tools.

1, 10mm Socket with Handle
1, 4mm Hex Wrench
1, 5mm Hex Wrench
1, Torque Wrench that accurately measures 75 inch pounds. (6.25 ft-lbs) (8.6 Nm)
Protective Tape and Flat Edge

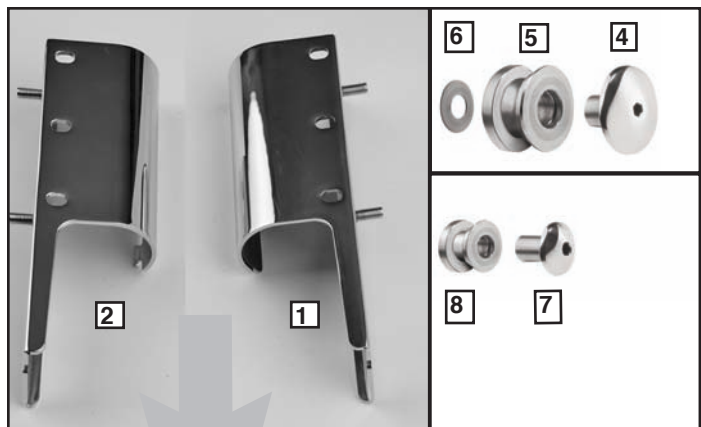

Left And Right Side Of Motorcycle Is Determined While Sitting On The Bike.

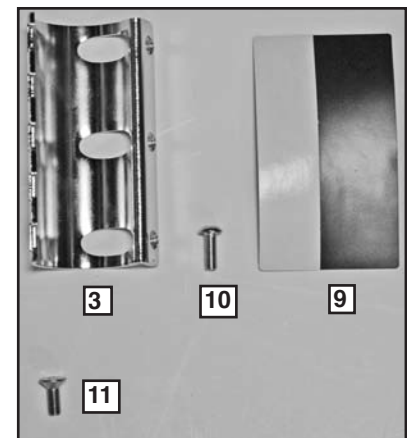

Preparation Continued

Cover upper and lower triple clamp with protective tape to prevent accidental scratching of chrome and painted surfaces.

 Space between upper and lower triple clamps is tight. For ease of installation, please follow instructions below.

Installation

Preparation Of Brackets

1. Install 1 Clamp Spacer (9) to each Inner Bracket (3) as shown. **Figure 2**

2. Install 1 Clamp Spacer (9) to the inside surface of each Outer Bracket (1 and 2) as shown. **Figure 3**



Figure 1

Start Taped Edge At Bottom Of Notch.
Do Not Cover Notch.

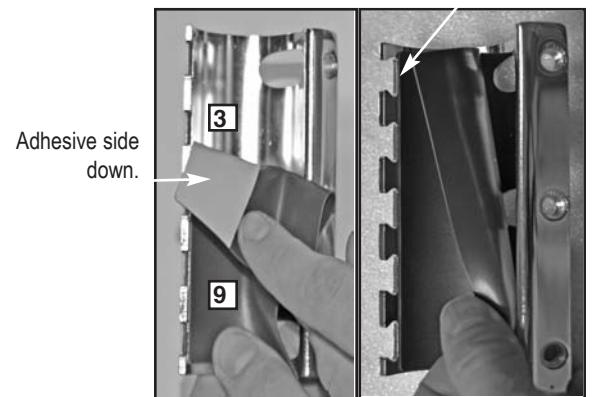

Figure 2

Loose Edge At Top Of Notch. Start Loose Edge At Top Of Notch.
Cover Notch

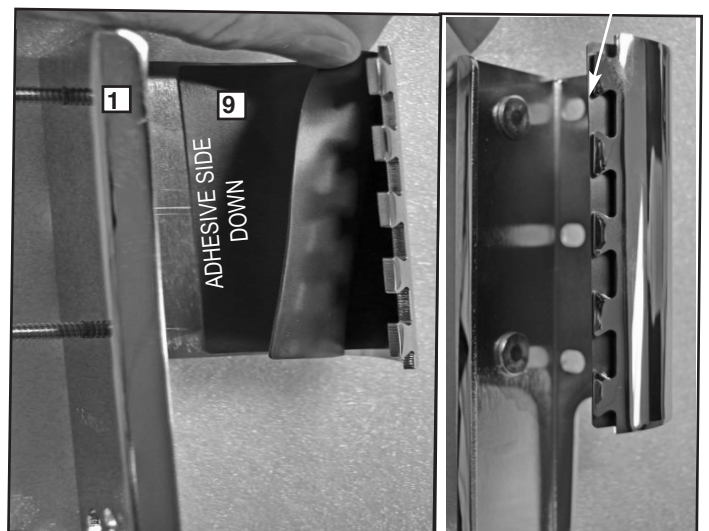

Figure 3

Remove Left Turn Signal from Motorcycle.

3. Remove turn signal clamp from motorcycle. **Figure 4 (10mm Socket)**

4. Remove turn signal from clamp. **Figure 5 (5mm Hex Wrench)**

Separate the rubber strap from the turn signal lamp by removing the hex socket cap screw located along the inside surface of the clamp.



Figure 4



Figure 5

Install Left Turn Signal to Left Bracket

5. Use one M6 Flat Screw (11) to install Turn Signal to Outer Bracket (1) **Figure 6**

 The bracket in Figure 6 shows a hole for turn signal wire. Your bracket will have a notch for ease of wire installation.

6. Orient turn signal head so nub in turn signal base aligns with small hole in bracket. **Figure 6**

7. Repeat steps 3-6 on right side of motorcycle.



Figure 6

Install Left Bracket Assembly To Motorcycle Fork

 The simulated fork pictures are provided to show more detail. The space between headlight and fork tube is close, follow the orientation of the bracket in figures 7-12 to attach the Outer and Inner Bracket to fork.

Start Low on the Fork Tube when placing Brackets. Final positioning will be done after Inner and Outer Brackets are loosely attached.

8. Position Outer Bracket on fork tube. Figures 7-9

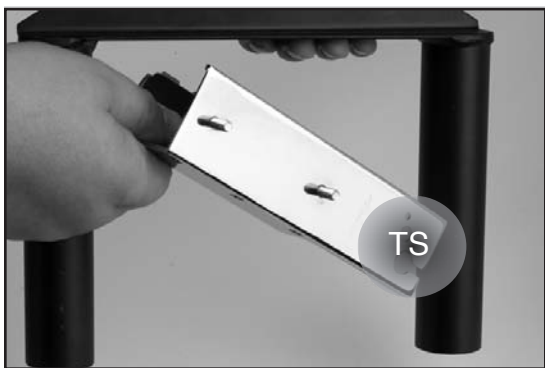

Figure 7. Studs on Outer Bracket (1) face outward at first.

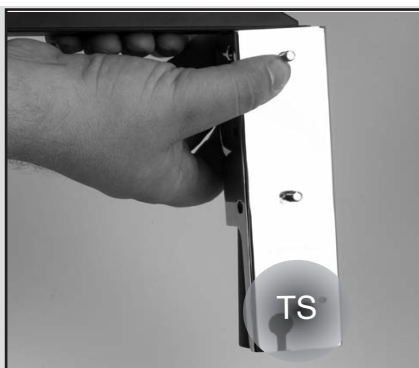

Figure 8.



Figure 9. Rotate studs to outside.

9. Position Inner Bracket on fork tube. Figures 10-12



Figure 10. Hold Outer Bracket (1) LOW on Triple Clamp. Inner Bracket (3) must slide between UPPER and LOWER WELD STUDS.



Figure 11. Slide Inner Bracket downward until edge clears UPPER WELD STUD.

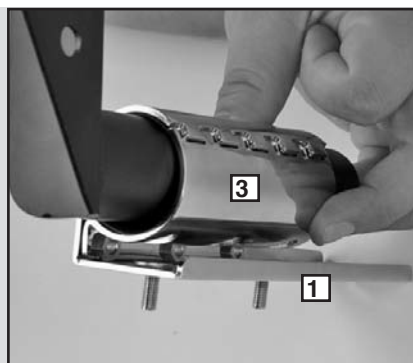

Figure 12. Bring notched edges of Inner Bracket together with Outer Bracket.

10. **Loosely** install Inner and Outer Bracket together using the M6 Button Screws (10). **Figure 13 (4mm Hex Wrench)**

11. Repeat steps 8-10 on right side of motorcycle.

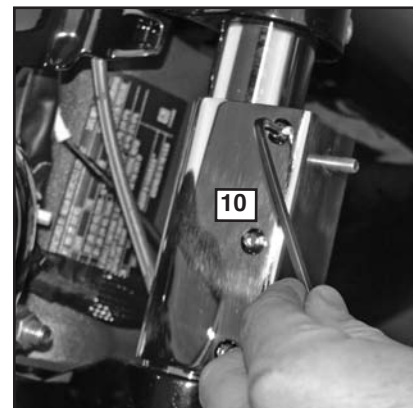



Figure 13

Upper and Lower Spools

 The Upper and Lower Spools come preassembled and properly torqued to the Bracket from the factory. Steps 12-17 are your guide to keeping the hardware in proper working order.

12. Place a Brass Washer (6) onto the top stud.

Figure 14

13. Push the large Upper Nut (4) into the large Upper Spool (5) so the thin side of the spool is near the head of the Upper Nut. **Figure 14**

14. Start the Upper Nut/Spool onto the upper stud. (4mm Hex Key)

15. Assemble the Lower Spool (8) and Lower Nut (7) so the thin side of the Spool is near the head of the Lower Nut. **Figure 14**

16. Start the Lower Nut/Spool onto the lower stud. (4mm Hex Key)

17. Repeat steps 12 through 16 on right fork Bracket.

Final Adjustment Of Clamps

 The Bracket spacing from the top or bottom triple clamp depends on the windshield being mounted. Refer to **figure 15** and the chart below.

Wave® QR Windshield.....2mm up from bottom triple clamp

SwitchBlade® Windshields....7mm down from top triple clamp

Spartan® Windshield.....7mm down from top triple clamp

18. Carefully slide the Clamp assemblies into position on the fork while fasteners are loosened. Tighten and torque the fasteners once final position is determined.

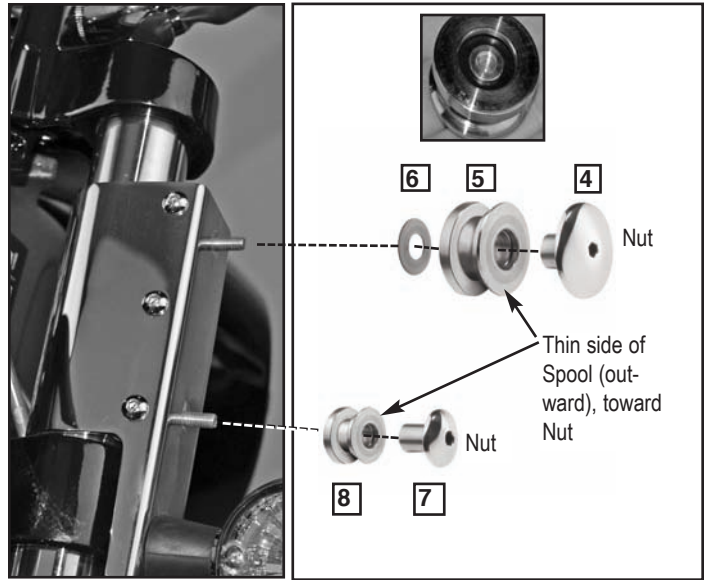

Figure 14



Figure 15

19. Adjust both Clamp Assemblies front to rear so they are in line across the forks. Lay a straight edge or yard stick across both brackets to align brackets. **Figure 17**

20. Adjust windshield so shield clears the headlight when you remove windshield.

⚠ Misalignment can cause damage to fuel tank and will cause the system to not work properly. Check alignment carefully. Turn the fork carefully to the stops. Make sure the gap between the Spools and the fuel tank are the same on both sides.

Tighten and Torque The M6 Button Head Screws

21. **Tighten the M6 Button Head Screws (10) to 6-8 ft/lbs (8-10 Nm) Figure 18. (Torque Wrench, 4mm Hex Wrench.)**

Check the Factory Torque Of The Nuts

👉 **Factory Torque Specification for Upper and Lower Nuts (4 and 7) is: 75 INCH POUNDS (8.6 Nm) (6.25 ft/lbs). Figure 19. (Torque Wrench, 4mm Hex Wrench.)**

(This assembly will not “feel” like tightening a normal nut and bolt. Tightening from 50 in/lbs to 75 in/lbs will take at least one full turn.)

22. Refer to the instructions packaged with the Quick Release Windshield. Install the shield. Make sure all components line up.

23. **Cycle the shield through the mount and dismount 5 times.**

24. **Retighten the Nuts to 75 INCH POUNDS (8.6 Nm) (6.25 ft/lbs).**

Enjoy your New Quick Release Windshield!

Visit www.Nationalcycle.com or your local dealer for a variety of National Cycle products for your Indian Scout.

REPLACEMENT PART BAGS

The following replacement parts can be ordered at www.nationalcycle.com or from your local dealer. For all other parts, please call National Cycle customer service.

BAG#1195

<u>INDEX</u>	<u>PART NUMBER</u>	<u>DESCRIPTION</u>	<u>QTY.</u>
4	34-340501-000	Nut, Upper	1
5	34-340510-000	Spool w/Bushing, Upper	1
6	49-490414-000	Washer, Brass	1

BAG#1196

7	34-340502-000	Nut, Lower	1
8	34-340512-000	Spool, Lower	1



Figure 17



Figure 18



Figure 19